



Palazzo
#pierolissoni

“Palazzo”
Quadro, Greca e Rombo
Pavimenti ispirati alla tradizione.

La collezione Palazzo intende rievocare, pur con linguaggio nuovo, i bei pavimenti tradizionali in legno o marmette, usando la matericità e i toni caldi, scuri della pietra lavica che, lavorata da nerosicilia con serigrafie in vetro lucido, trasforma gli stilemi classici in una sorta di preziosa filigrana.

“Palazzo”
Quadro, Greca and Rombo
Floors inspired by tradition.

The Palazzo collection aims to use a new language to evoke beautiful traditional wood and marble floors, taking full advantage of the substance and warm, dark tones of volcanic stone. Processed by nerosicilia with screen printing on polished glass, it transforms classic stylistic features into a delicate filigree.

Palazzo Quadro

Caratteristiche Tecniche Technical Data

Superfici Surfaces



Formati Size

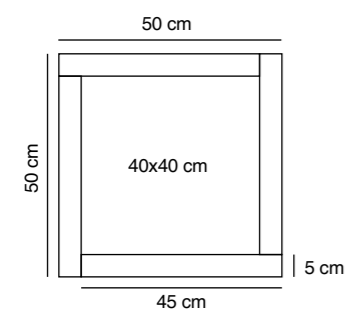

≠ spessore | thickness 1cm \ 2cm

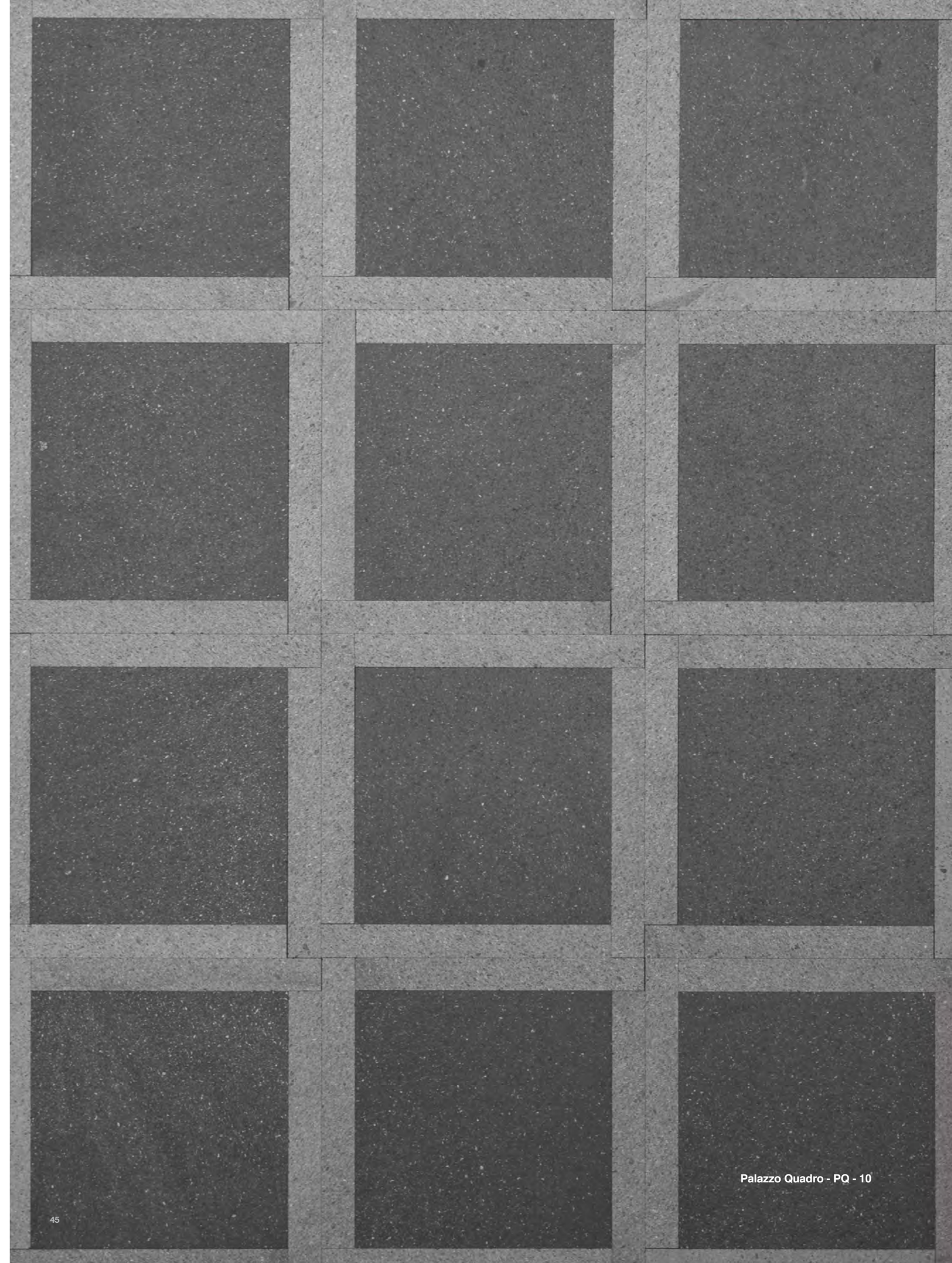

Palazzo Quadro - PQ - 10



Palazzo Rombo

Caratteristiche Tecniche
Technical Data

Superfici
Surfaces



G rombo bianco



G rombo nero

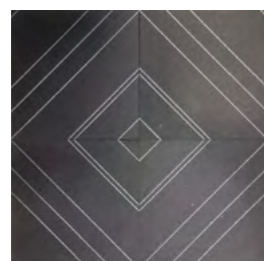

N rombo bianco

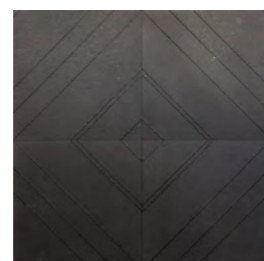

N rombo nero

Formati
Size

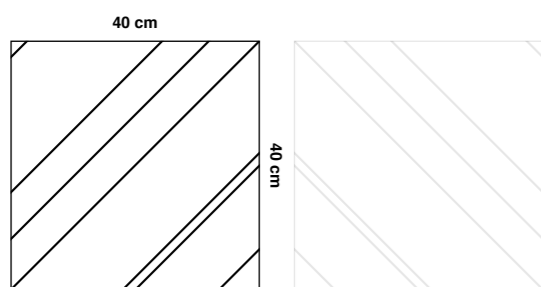

≠ spessore | thickness 1cm



Palazzo Rombo - N rombo nero

Palazzo Greca

Caratteristiche Tecniche
Technical Data

Superfici
Surfaces

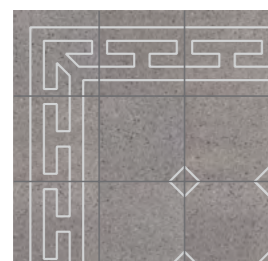

G greca bianco

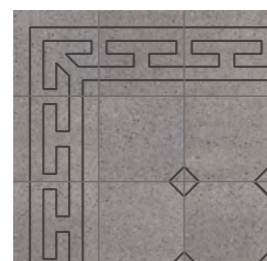

G greca nero

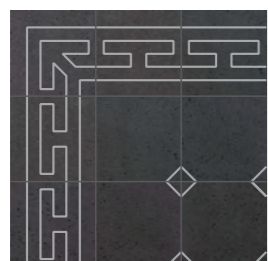

N greca bianco

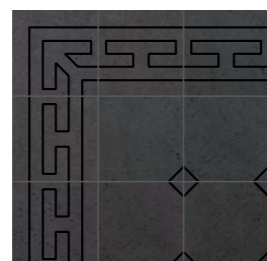

N greca nero

Formati
Size

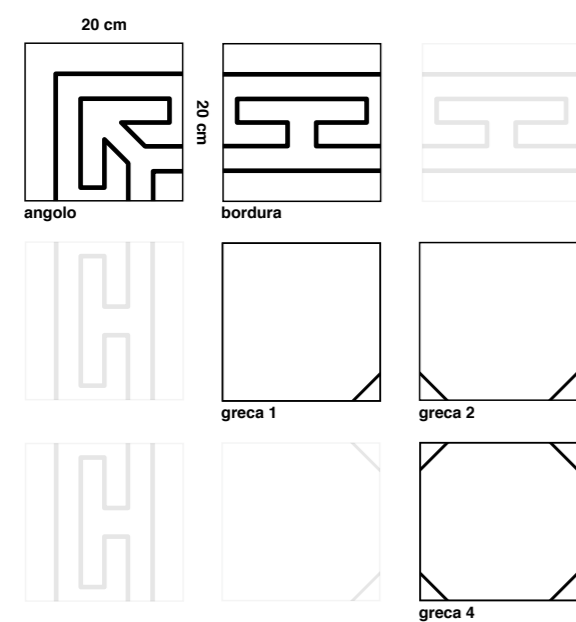

spessore | thickness 1cm



Palazzo Greca - G greca bianco

Caratteristiche tecniche | Technical features

Superfici Surfaces		laNera laRoccia enneDue enneTre	enneUno
Assorbimento Water absorption	ISO 10545-3	0,64	1,15
Resistenza a flessione Flexion resistance	ISO 10545-4	3513 3162 10,3	3437 3093 9,6
Abrasione profonda Deep abrasion	ISO 10545-6	242	240
Sbalzi termici Shock resistance	ISO 10545-9	Resistente Resistant	Resistente Resistant
Attacco chimico Chemical resistance	ISO 10545-13	UA,ULB, ULC,UHC	UA,ULB, ULC,UHC
Gelo Frost resistance	ISO 10545-12	Resistente Resistant	Resistente Resistant
Resistenza alle macchie Resistance to stains	ISO 10545-14	2 5 1	1 5 1
Scivolosità Anti-Slip characteristics	DIN 51130	14,2° R10-R12	13° R10-R12

Consigli di posa | Laying guide

Rasatura della parete | Shaving (leveling) the wall

Assicurarsi che la superficie da rivestire sia perfettamente rasata, planare e non presenti residui di polvere. In presenza di supporti assorbenti è necessario stendere sulla superficie uno strato di Primer. Per ulteriori informazioni rivolgersi presso un rivenditore di prodotti chimici per edilizia.

Check that the foundation is completely shaved (smooth) and uniform and there is not superficial dust. In case of absorbent surfaces apply a primer on the wall. Eventually please consulting a dealer.

Collante | The glue

Si può usare qualsiasi collante in commercio adatto alla posa delle pietre naturali. Il tipo di collante può cambiare a seconda della superficie da rivestire. Per maggiori info rivolgersi a un rivenditore specializzato.

It's possible to use every glue suitable for the laying of natural stones. The type of the glue depends on the surface to cover. Eventually please consulting a dealer.

Stuccatura | Grouting

nerosicilia consiglia la fuga cementizia in tono. Per maggiori informazioni rivolgersi presso un rivenditore autorizzato.

nerosicilia advise to use the colour of grout tone on tone. Eventually consult authorized dealer.

Cura + manutenzione | Care + maintenance

nerosicilia viene fornito già con trattamento idro-olio-repellente antimacchia antibatterico.

In caso di macchie procedere come segue:

- Pulire bene la superficie con un detergente idoneo per le pietre naturali; il prodotto da noi consigliato è Fila PS87, da usare diluito con acqua secondo le istruzioni d'uso.
- Utilizzare un prodotto antimacchia idoneo per le pietre naturali, che non ne alteri il tono. Il prodotto da noi consigliato è il GAP 28.
- SOLO SULLA NERA E NERODECORO è possibile utilizzare un tonalizzante specifico per le pietre naturali (esempio FILA STONE PLUS).
- ATTENZIONE, non usare Fila Stone Plus sulla enneUno e Textone enneUno perché potrebbe modificarne il tono.

nerosicilia is supplied with oil and waterproof, stain resistant and anti-bacterial treatment.

In case of stains proceed as follows:

- Purify the surface with a suitable cleanser for natural stones; the product we recommend is Fila PS87, to use diluted with water according to the instructions for use.
- Use a stain resistant product suitable for natural stones, which do not modify the tone. The product we recommended is the GAP 28.
- ONLY ON LANERA AND NERODECORO you can use a specific tonic for natural stones (ex. FILA STONE PLUS).
- CAUTION, do not use Fila Stone Plus on enneUno and Textone enneUno because it could change the tone.

Applicazioni | Applications

Rivestimenti per esterni External walls covering	X	X
Pavimenti esterni External flooring	X	X
Muri interni Internal walls covering	X	X
Pavimenti interni Internal flooring	X	X
Top cucina Kitchen top	X	X
Altre superfici Different surfaces	X	X
Traffico Traffic	heavy commercial	heavy commercial

Imballo | Packing

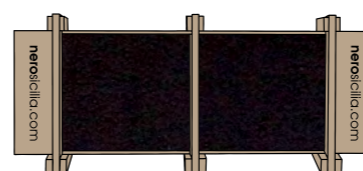

bundle 1
n°15 lastre 80x300 cm (36,00 mq)
misure bundle 87x310x1107h cm
kg bundle 2.250,00

n°15 slabs 80x300 cm (36,00 mq)
size bundle 87x310x1107h cm
kg bundle 2.250,00

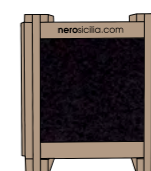

bundle 2
n°32 pezzi 80x80 cm (20,48 mq)
misure bundle 87x80x99h cm
kg bundle 1.228,80

n°32 pcs 80x80 cm (20,48 mq)
size bundle 87x80x99h cm
kg bundle 1.228,80

	spessore cm thickness cm	imballo packaging	pezzi-box pcs-box	mq-box sqm-box	kg-box kg-box	box-pal box-pal	pezzi-pal pcs-pal	mq-pal sqm-pal	kg-pal kg-pal	
5x20 cm	1	box	24	0,24	7,2	105	2520	25,2	756	☰
10x10 cm	1	box	24	0,24	7,2	105	2520	25,2	756	□
10x20 cm	1	box	12	0,24	7,2	105	1260	25,2	756	▭
20x20 cm	1	box	6	0,24	7,2	105	630	25,2	756	□
20x40 cm	1	box	4	0,32	9,6	120	480	38,4	1152	▭
40x40 cm	1	box	2	0,32	9,6	120	240	38,4	1152	□
40x80 cm	1	bundle	2	0,64	19,2	60	120	38,4	1152	▭
5x20 cm	2	box	12	0,12	3,6	105	1260	12,6	756	☰
10x10 cm	2	box	12	0,12	3,6	105	1260	12,6	756	□
10x20 cm	2	box	6	0,12	3,6	105	1260	12,6	756	▭
20x20 cm	2	box	3	0,12	3,6	105	1260	12,6	756	□
20x40 cm	2	box	2	0,16	4,8	120	240	19,2	1152	▭
40x40 cm	2	box	1	0,16	4,8	120	120	19,2	1152	□
40x80 cm	2	bundle	1	0,32	9,6	60	60	19,2	1152	▭
80x80 cm	2	bundle	-	-	-	-	32	20,48	1229	□
80x120 cm	2	bundle	-	-	-	-	32	30,72	1843	▭
listone										
20x 200-300 cm	2	bundle								▭
40x 200-300 cm	2	bundle								▭
20x free length cm	2	bundle								▭
40x free length cm	2	bundle								▭
slabs										
80 x 120-150 cm	2	bundle								▭
80 x 150-250 cm	2	bundle								▭
80 x 250-300 cm	2	bundle								▭